

Miele

Operating and installation instructions

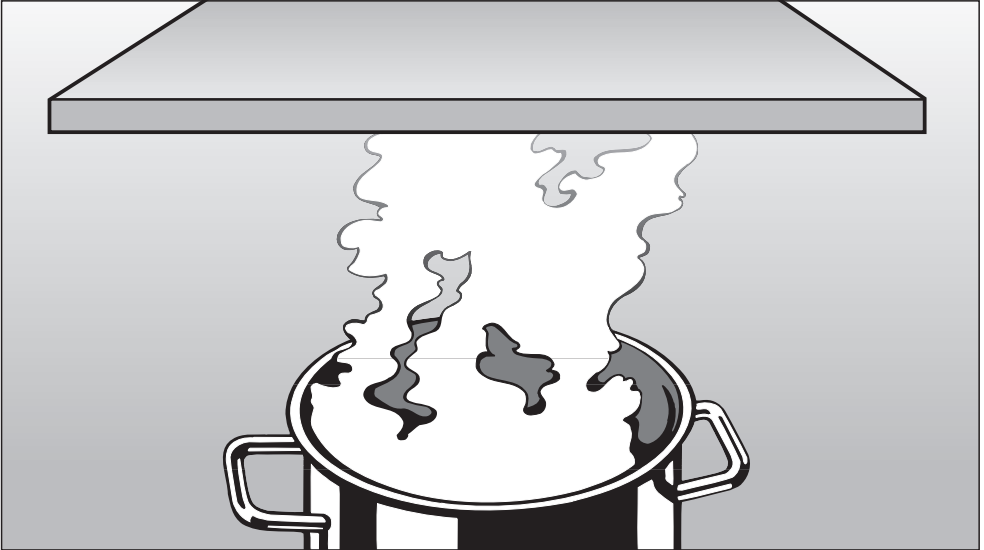

Ventilation System DA 279-3

To prevent accidents
and machine damage,
read these instructions
before installation or use.



M.-Nr. 05 853 690

Table of Contents

IMPORTANT SAFETY INSTRUCTIONS	4
Guide to the appliance	8
Functional description	10
Operation	11
Main power switch	11
Turning on the fan	11
Selecting the power level	11
Delayed Shut Down	12
Turning off the fan	12
Turning the lighting on/off	13
Dimming the lighting	13
Indirect lighting	13
Filter timers	14
Checking the filter timers	14
Reprogramming the timers	15
Cleaning and Care	17
Cleaning the casing	17
Grease filters	18
Active charcoal filter	19
Changing the light bulb	20
After Sales Service	21
Installation instructions	23

IMPORTANT SAFETY INSTRUCTIONS

Read these Operating Instructions carefully before installing or using the Ventilation System.

This appliance is intended for residential use only. Use the appliance only for its intended purpose. The manufacturer cannot be held responsible for damages caused by improper use of the hood.

This appliance complies with current safety requirements. Improper use of the appliance can lead to personal injury and material damage.

READ AND SAVE THESE INSTRUCTIONS

CAUTION

For General Ventilating Use Only.
Do Not Use To Exhaust Hazardous
Or Explosive Materials And Vapors.

■ This appliance is designed to vent cooking smoke and odors only.

■ Be certain your appliance is properly installed and grounded by a qualified technician.

To guarantee the electrical safety of this appliance, continuity must exist between the appliance and an effective grounding system. It is imperative that this basic safety requirement be met. If there is any doubt, have the electrical system of the house checked by a qualified electrician. The manufacturer can not be held responsible for damages caused by the lack, or inadequacy of, an effective grounding system.

■ Before connecting the appliance to the power supply make sure that the voltage and frequency listed on the data plate correspond with the household electrical supply. This data must correspond to prevent machine damage. Consult a qualified electrician if in doubt.

■ Installation work and repairs should only be performed by a qualified technician in accordance with all applicable codes and standards. Repairs and other work by unqualified persons could be dangerous and the manufacturer will not be held responsible.

IMPORTANT SAFETY INSTRUCTIONS

■ This equipment is not designed for maritime use or for use in mobile installations such as caravans or aircraft. However, under certain conditions it may be possible for an installation in these applications. Please contact the nearest Miele dealer or the Miele Technical Service Department with specific requirements.

■ Before servicing or cleaning the unit, switch power off at the service panel and lock the service disconnecting means to prevent power from being switched on accidentally. When the service disconnecting means can not be locked, securely fasten a prominent warning device, such as a tag, to the service panel.

■ Before discarding an old appliance, unplug it from the power supply and remove the power cord and any doors to prevent hazards.

Use

■ Do not allow children to play with or operate the appliance or its controls. Supervise its use by the elderly or infirm.

■ Be careful when preparing a flambé beneath the hood. Flames may be drawn up into the hood by the suction or grease filters may catch fire.

■ Never operate gas burners without pots.

■ Do not leave cooking surfaces unattended while in use. Overheated food, oil and grease can catch fire.

■ Do not use the hood without the grease filters in place.

■ Clean the grease filters regularly. Dirty filters are a fire hazard.

■ Do not use a steam cleaner to clean the hood. Steam could penetrate electrical components and cause a short circuit.

■ In areas subject to infestation by cockroaches or other pest, keep the appliance and its surroundings clean at all times. Any damage caused by cockroaches or other pest will not be covered under warranty.

IMPORTANT SAFETY INSTRUCTIONS

WARNING - TO REDUCE THE RISK OF A RANGE TOP GREASE FIRE:

 Never leave surface units unattended at high settings. Boilovers cause smoking and greasy spillovers may ignite. Heat oils slowly on low or medium settings.

 Always turn hood "ON" when cooking at high heat or when cooking flaming foods.

 Clean ventilating fans frequently. Grease should not be allowed to accumulate on fan or filter.

 Use proper pan size. Always use cookware appropriate for the size of the surface element.

WARNING TO REDUCE THE RISK OF INJURY TO PERSONS IN THE EVENT OF A RANGE TOP GREASE FIRE, OBSERVE THE FOLLOWING:

 **SMOTHER FLAMES** with a close fitting lid, cookie sheet, or metal tray, then turn off the burner.

BE CAREFUL TO PREVENT BURNS. If the flames do not go out immediately, **EVACUATE AND CALL THE FIRE DEPARTMENT.**

 **NEVER PICK UP A FLAMING PAN** - You may be burned.

 **DO NOT USE WATER**, including wet dishcloths or towels - a violent steam explosion will result.

 Use an extinguisher **ONLY IF:**

- You know you have a Class ABC extinguisher, and you already know how to operate it.
- The fire is small and contained in the area where it started.
- The fire department is being called.
- You can fight the fire with your back to an exit.

IMPORTANT SAFETY INSTRUCTIONS

Installation

 **WARNING**
To reduce the risk of fire, only use metal ductwork.

 When installing the hood, follow the recommended minimum safety distances between a Miele cooktop and the hood:

- 22" (55 cm) above electric cooktops,
- 26" (65 cm) above gas cooktops,
- 26" (65 cm) above an open grill.

If local building codes require a greater safety distance, follow their requirement.

For non-Miele cooking appliances maintain the safety distances recommended by the appliance manufacturer in their installation and operating instructions.

If there is more than one appliance beneath the hood and they have different minimum safety distances always select the greater distance.

 Be careful not to damage hidden electrical wiring or plumbing when cutting or drilling into the wall or ceiling.

 Do not use an extension cord to connect the appliance to electricity. Extension cords do not guarantee the required safety of the appliance, (e.g. danger of overheating).

 Do not install this hood over cooktops burning solid fuel.

 Any fittings, sealant, or materials used to install the ductwork must be made of approved non-flammable materials.

 Never connect an exhaust hood to an active chimney, dryer vent, vent flue, or room ventilating ductwork. Seek professional advice before connecting an exhaust hood vent to an existing, inactive chimney or vent flue.

 Ducted fans must always be vented outdoors.

 Make sure that the airflow in the room is sufficient for combustion and exhausting of all non-electric heating appliances (water heaters, gas cooktops, gas ovens, etc.), otherwise backdrafts may occur. Follow the heating manufacturer's guidelines and safety standards or those published by the National Fire Protection Association (NFPA), or the American Society for Heating, Refrigeration and Air Conditioning Engineers (ASHRAE). If in doubt, consult an experienced professional.

Guide to the appliance

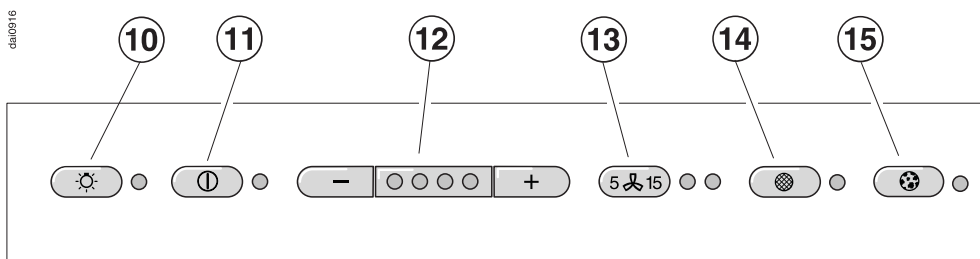
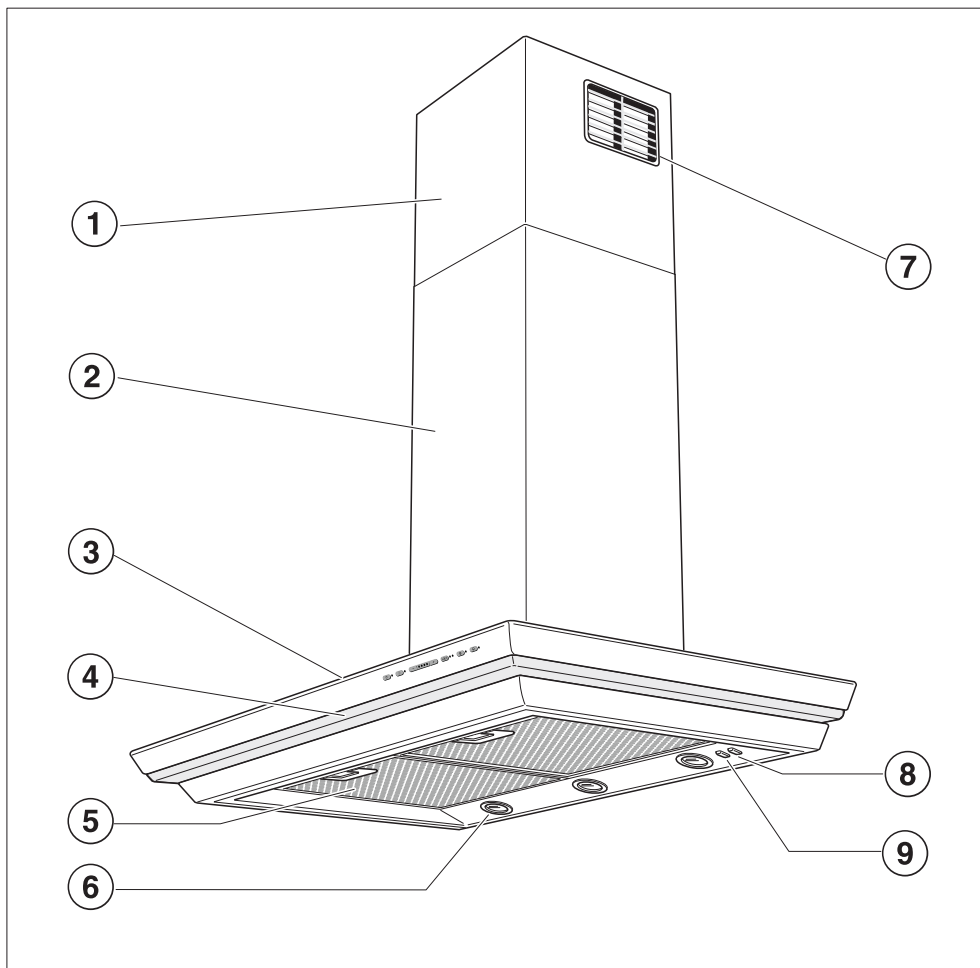

da100316

① Chimney extension

② Chimney

③ Canopy

④ Indirect lighting

⑤ Grease filter

⑥ Overhead lighting

⑦ Recirculation vent

⑧ Main power switch

⑨ Indirect lighting switch

⑩ Light button

This button turns the light on and off and also dims the light.

The lighting can be used independently of the fan.

⑪ On/Off button

⑫ Fan power selection

Four fan speed selection

⑬ Delayed shut down

This button activates the Delayed Shut Down feature. The fan can be set to turn off automatically after either 5 or 15 minutes.

⑭ Grease filter button

The indicator next to the grease filter button lights when the grease filters need to be cleaned. This button is also used:

- to reset the grease filter timer after cleaning the grease filters (see "Cleaning and Care").
- to show how long the grease filters have been in use (see "Operation / Filter timers").
- to change the number of hours counted by the grease filter timer (see "Operation / Reprogramming the filter timers").

⑮ Charcoal filter button

The indicator next to the charcoal filter button lights when the charcoal filter needs to be replaced.

This button is also used:

- to reset the charcoal filter timer after changing the filter (see "Cleaning and care").
- to show how long the charcoal filter has been in use (see "Operation / Filter timers").
- to change the number of hours counted by the charcoal filter timer (see "Operation / Reprogramming the timers").

Functional description

The hood offers two modes of operation:

Air extraction

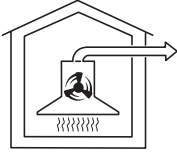

The air is drawn in and cleaned by the grease filters and directed outside.

The hood comes equipped with a **non-return flap**. This flap automatically closes when the hood is turned off so that no exchange of outside air and room air can occur. When the hood is turned on, the air pressure of the exhaust fan automatically opens the flap blowing the inside air and cooking odors outside.

Recirculation mode



Air is drawn through the grease filters and an **active charcoal filter**. The filtered air is then recirculated back into the kitchen through a vent at the top of the hood's chimney.

Before using the hood in recirculation mode, ensure that the active charcoal filter is in place, see "Cleaning and care".

Main power switch

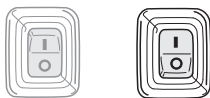

- Press the main power switch to "I".
The fan and lighting are ready to use.

If the appliance is not going to be used for a long period of time (e.g. while vacationing) it should be turned off at the main power switch to "0".

The next time it is turned on, the hood will operate at the level previously used.



Turning on the fan



- Press the On/Off button.

Selecting the power level



- Use the   controls to select the desired power level.

 =increases the fan speed

 =decreases the fan speed

Level "1" to "3" (green indicators) are usually sufficient for normal cooking.

Intensive setting

Level "4" (yellow indicator) should be used for a short period when frying or cooking food with a strong aroma.

Fan performance

The maximum air flow capacity is 625 cfm. Factors such as narrow duct diameter and bends will affect this value.

There will also be a slight decrease in airflow for hoods operated in recirculation mode due to the active charcoal filter.

Level 1 operates at 40% capacity

Level 2 operates at 60% capacity

Level 3 operates at 80% capacity

Level 4 operates at 100% capacity

Operation

Delayed Shut Down

If odors or smoke remain in the kitchen after cooking has been completed, the Delayed Shut Down feature can be selected to allow the hood to continue running for either 5 or 15 minutes.

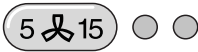

- Press the Delayed Shut Down button while the fan is still running.

Press once = 5 minute delay
(left indicator lights)

Press twice = 15 minute delay
(right indicator lights)

To cancel the Delayed Shut Down feature press the button again.

Turning off the fan



- Press the On/Off button to turn the fan off.

The indicator goes out.

Automatic Safety Shut Off

The fan will turn off automatically 10 hours after the last button was activated. The lighting however will remain on.

- Press the On/Off button to turn the fan back on again.

Turning the lighting on/off

The overhead lighting can be turned on and off independently of the fan.



- Press the light button **briefly** to turn on the lighting.

The light button indicator illuminates.

- Press the light button **briefly** again to turn off the lighting.

The light button indicator will go out.

Dimming the lighting

The brightness of the lighting can be adjusted.

- While the lighting is turned on, press the light button.
The lighting will dim until the button is released.
- If the button is pressed again, the lighting will brighten until the button is released.

If the button is pressed continuously, the light will cycle between bright and dark.

- Press the light button again to turn off the lighting.

Indirect lighting

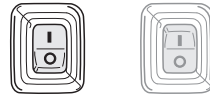

- Press the indirect lighting switch to "I".

The indirect lighting can be turned on when the main power switch is off.

Operation

Filter timers

Grease filters



A timer monitors the hours of fan operation. The indicator for the grease filter will light after 30 hours of operation. The grease filters must then be cleaned.

After the grease filters have been cleaned and put in place, the grease filter timer must be reset.

- To do this, press the grease filter button for about 3 seconds.

The indicator will go out.

Charcoal filter

Recirculation mode only

The timer for the charcoal filter is not preset. Please program this timer, see "Operation/Reprogramming the charcoal filter timer".



The charcoal filter indicator will light once the selected time has elapsed. The charcoal filter must then be replaced and the charcoal filter timer reset.

- To do this, press the charcoal filter button for about 3 seconds.

The indicator will go out.

Checking the filter timers

To check the percentage of time already used:



- Press the On/Off button to turn the fan on.



- Press the grease or charcoal filter button.



The number of flashing  indicators show the percentage of programmed hours that have been used.

- 1 indicator = less than 25 %
- 2 indicators = less than 50 %
- 3 indicators = less than 75 %
- 4 indicators = less than 100 %

This information will remain stored in memory in the event of a power failure.

Reprogramming the timers

The grease filter timer is preset to 30 hours. This time can be lengthened or shortened to 20, 30, 40 or 50 hours.

- A time of 20 hours should be programmed in kitchens with frequent pan or deep frying.
- A time of 20 hours should also be programmed if the kitchen is only used occasionally to prevent grease which has accumulated over a long period of time from hardening on the filters making cleaning more difficult.

Reprogramming the grease filter timer



- Press the On/Off button to turn off the fan.



Press the Delayed Shut Down and grease filter buttons at the same time.

The indicator for the grease filter and one of the indicators will flash.



The lit indicator shows the programmed time:

- 1st indicator from the left = 20 hours
- 2nd indicator from the left = 30 hours
- 3rd indicator from the left = 40 hours
- 4th indicator from the left = 50 hours

- Use the or button to select the desired time.



- Store the selection by pressing the grease filter button.

If the procedure is not stored within 4 minutes of programming, the hood will automatically default to the "old" data.

Operation

Reprogramming the charcoal filter timer

The active charcoal filter can only be used in recirculation mode and can not be used to exhaust fumes.

The charcoal filter timer is not **not pre-set**.

Before using the hood in recirculation mode, the charcoal filter timer must be programmed.



- Turn off the fan using the On/Off button.





- Press the Delayed Shut Down and charcoal filter buttons at the same time.

The indicator for the charcoal filter and one of the  indicators will flash.



The lit indicator shows the programmed time:

- 1st indicator from the left = 20 hours
- 2nd indicator from the left = 30 hours
- 3rd indicator from the left = 40 hours
- 4th indicator from the left = 50 hours

- Use the  or  button to select the desired time.



- Store the selection by pressing the charcoal filter button.

If the procedure is not stored within 4 minutes of programming, the hood will automatically default to the "old" data.

Before cleaning or servicing the hood, disconnect it from the power supply by either removing the fuse, unplugging it from the outlet or manually "tripping" the circuit breaker.

Cleaning the casing

Warning: Never use abrasive cleaners, scouring pads, steel wool or caustic (oven) cleaners on the hood. They will damage the surface.

- All external surfaces and controls can be cleaned with warm water and liquid dish soap applied with a soft sponge.
- Wipe dry using a soft cloth.

Do not use too much water when cleaning the controls. Water could penetrate into the electronics and cause damage.

- Glass surfaces can be cleaned using glass cleaner.

Avoid:

- cleaning agents containing soda, acids or chlorides,
- abrasive cleaning agents e.g. powder or cream cleansers,
- abrasive sponges, e.g. pot scourers or sponges which have been previously used with abrasive cleaning agents.

These will damage the surface.

Stainless steel

Stainless steel surfaces can be cleaned using a non-abrasive stainless steel cleaner.

To help prevent resoiling, a conditioner for stainless steel can also be used. Apply sparingly with even pressure.

Stainless steel colored controls

These controls may become discolored or damaged if not cleaned regularly.

Do not use a stainless steel cleaner on these controls.

Cleaning and Care

Grease filters

The reusable metal grease filters remove solid particles from the vented kitchen air (grease, dust, etc).

The grease filters should be cleaned every 3 - 4 weeks or whenever the grease filter indicator lights.

A dirty filter is a fire hazard.

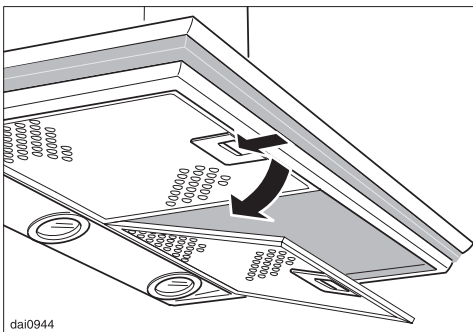

- To remove the grease filters press the locking clips in towards the middle of the filter. Support grease filter so that it does not fall on to the cooktop.

- Clean the filters
 - **by hand:** use a scrub brush in warm water with a mild detergent.
 - **in a dishwasher:** place the filters vertically in the lower basket, making sure that the spray arm is not blocked.

Depending on the detergent, cleaning the grease filters in a dishwasher may cause permanent discoloration of the filter surface. Performance of the filter will not be affected by this discoloration.

- After cleaning, the filters can be placed on a towel to air dry.
- While the filters are removed, clean any dirt or grease from the filter casing to prevent the risk of fire.

When putting the grease filters back make sure that the locking clips are visible facing the cooking surface.

If the filters are incorrectly installed, insert a small screwdriver into the slit along its edge to disengage it from the casing.

- After returning the grease filters, press the grease filter button for 3 seconds to reset the timer. The indicator light will go out.
- If the grease filters are cleaned before the grease filter timer has reached its maximum, the grease filter button should be pressed for 6 seconds to reset the counter to zero.

Active charcoal filter

In recirculation mode an active charcoal filter must be used in addition to the grease filters. The charcoal filter is designed to absorb cooking odors. The active charcoal filter will be placed in the canopy above the grease filters.

Replacement active charcoal filters (part # 03 284 680) can be ordered from the Miele Technical Service Department.

USA 1-800-999-1360
CDN 1-800-565-6435

- The grease filters must be removed to access the active charcoal filter. See "Cleaning and Care".
- Two support angles must be installed (see Installation manual to support the charcoal filter.)

The active charcoal filter comes boxed with 2 filters. For best results, tightly seal the bag containing the remaining filter.

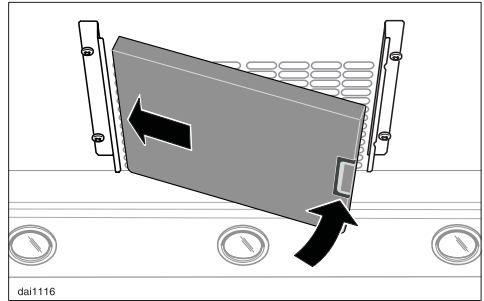

- Insert the charcoal filter.

Before using:

- Program the charcoal filter timer, see "Operation/Reprogramming the charcoal filter timer".



Replace the active charcoal filter when the **charcoal filter indicator** lights. Replace the filter at least every 6 months or when it no longer absorbs odors efficiently.

- After replacing the charcoal filter, press and hold the charcoal filter button for about 3 seconds to reset the charcoal filter timer. The indicator light will go out.
- If the charcoal filter is replaced before the timer has reached its maximum, the charcoal filter button should be pressed for 6 seconds to reset the counter to zero.

Cleaning and Care

Changing the light bulb

Before changing the light bulbs, disconnect the hood from the power supply by either removing the fuse, unplugging it, or manually "tripping" the circuit breaker.

When in use halogen bulbs become extremely hot, and they can burn your hands. Do not attempt to change the bulbs until they have had sufficient time to cool down.

Do not touch the bulb surface. Fingerprints or body oils deposited on the bulb will decrease the life of the bulb.

Please follow the bulb manufacturer's instructions.

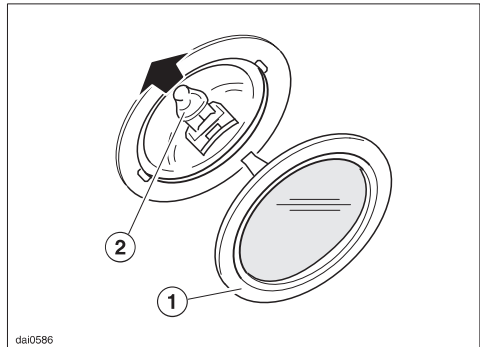

- To change the halogen bulb first remove the lamp cover, ①.
- Pull the bulb, ②, out of its socket and replace with a new one.
- Return the lamp cover, ①.

Never use the lighting without the lamp cover, ①, in place. The glass is specially made to filter harmful light rays.

In the event of a fault which you cannot correct yourself please contact:

– Your Miele Dealer

or

– The Miele Technical Service
Department

USA 1-800-999-1360
techserv@mieleusa.com

CDN 1-800-565-6435
service@miele.ca

When contacting the Technical Service Department, please quote the model and serial number of your appliance. These are shown on the data plate which is visible when the grease filter is removed.

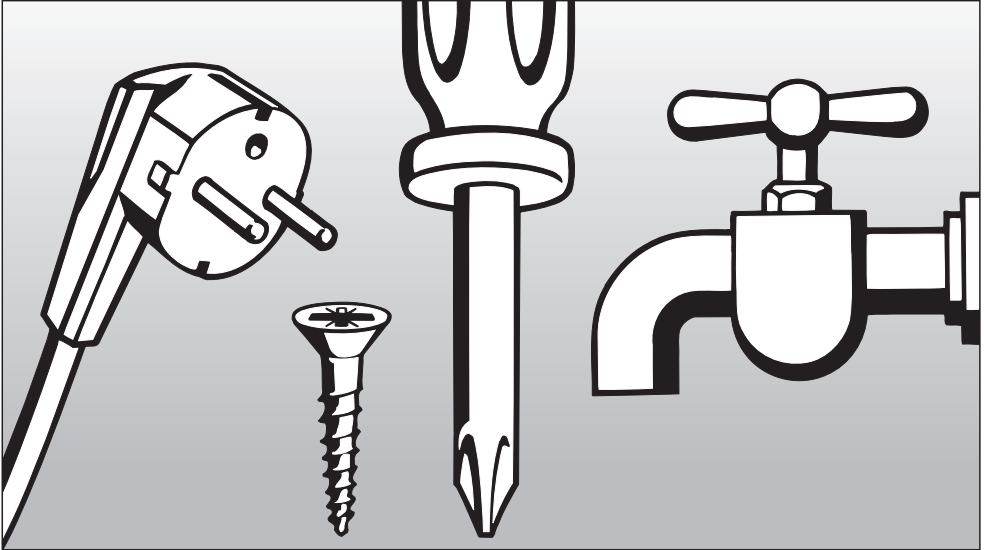

Installation instructions

Table of Contents

Caring for the environment	25
Installation accessories	26
Plywood backing	28
Electrical data	29
Appliance dimensions	30
Installation	32
Installation instruction	32
Dismantling	32
Air extraction	33
Condensate trap	34

Disposal of packing material

The cardboard box and packing materials protect the appliance during shipping. They have been designed to be biodegradable and recyclable. Please recycle.

Ensure that any plastic wrappings, bags etc. are disposed of safely and kept out of the reach of children.
Danger of suffocation!

Disposal of an old appliance

Old appliances may contain materials that can be recycled. Please contact your local recycling authority about the possibility of recycling these materials.

Before discarding an old hood, unplug it from the outlet and cut off its power cord to prevent hazards.

Installation accessories

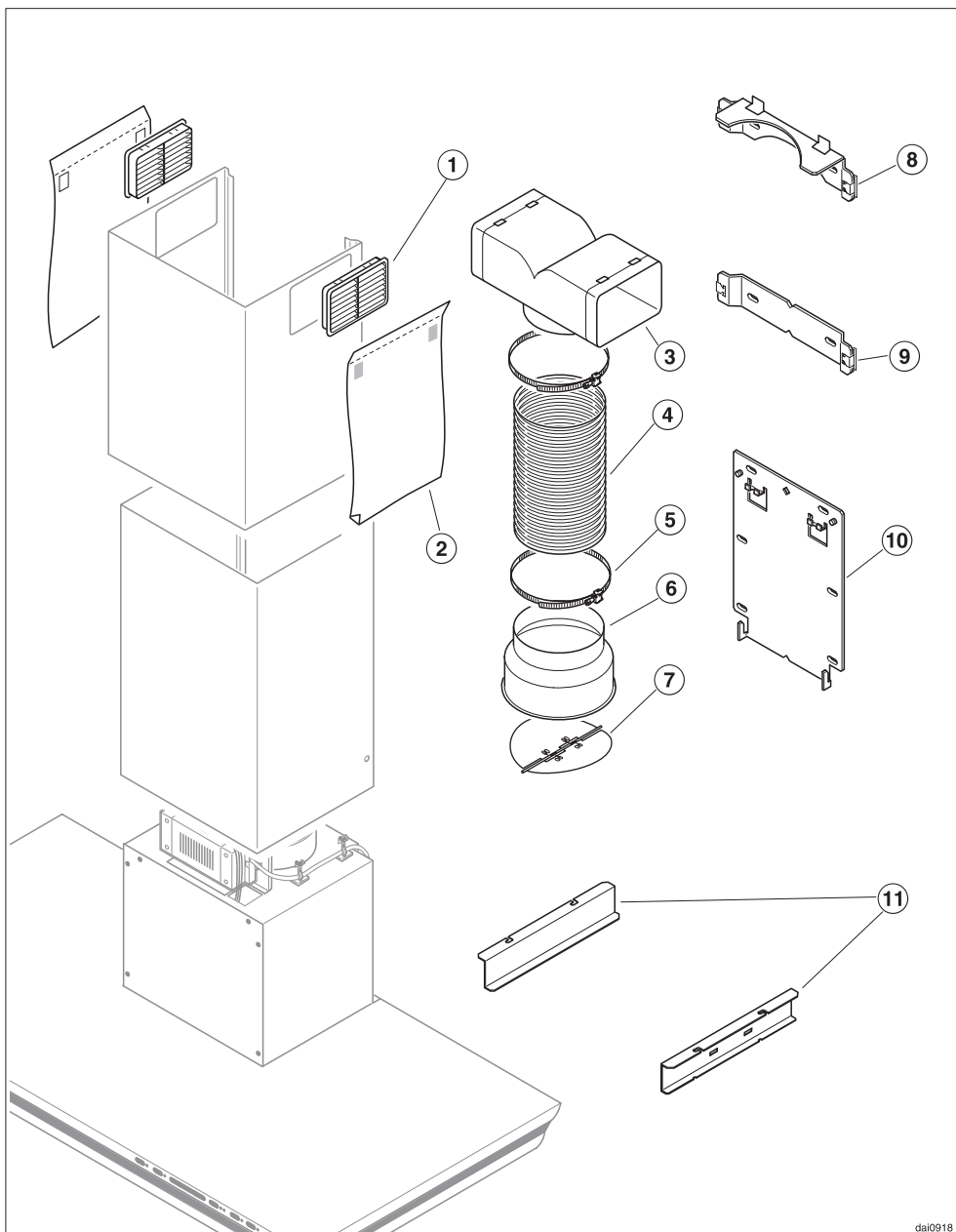

dal0918

Installation accessories

- ① **2 recirculation vents**
(recirculation mode only)
- ② **2 protective shields**
prevent scratches to the chimney during installation.
- ③ **1 diverter**
(recirculation mode only)
- ④ **1 flex hose** for connecting the diverter to the exhaust connection.
- ⑤ **2 hose clips** for securing the ducting.
- ⑥ **1 reducing collar**
for use with 5" (125 mm) exhaust ducting.
- ⑦ **1 non-return flap** for vented air extraction only.
- ⑧ **Upper retaining plate** secures the chimney extension.
- ⑨ **Middle retaining plate** for additional stability of the chimney.
- ⑩ **Lower retaining plate** secures the canopy and motor assembly.
- ⑪ **2 support angles** to secure the active charcoal filter in recirculation mode.

Caution: During the installation process, please be careful of sharp edges that can cause harm.

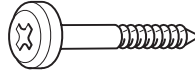

8 large headed screws 5 x 40 mm
for securing the retaining plates and the canopy.

(S8 wall anchors included in the packaging are not for use in USA / CDN.)



2 M 6 locking nuts for securing the motor assembly.



2 screws 3.9 x 7.5 mm for securing the chimney.

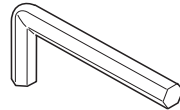

1 allen wrench
for adjusting the unit height

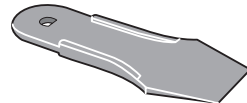

1 lever for dismantling the chimney

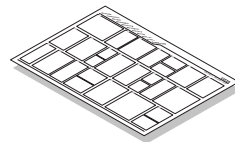

Installation instruction sheet

Plywood backing

The majority of the weight of the installed ventilation system will be supported by the lower retaining plate. It must be firmly attached to the stud framing behind the drywall. If studs are not available in the required locations, a plywood backing (min. $\frac{1}{2}$ " (13 mm) thick) spanning at least two studs must be installed. Failure to adequately support the weight as stated may result in the ventilation system falling off the wall, causing personal injury and property damage.

(If plywood backing is not needed, proceed to the included installation sheet.)

To install a plywood backing

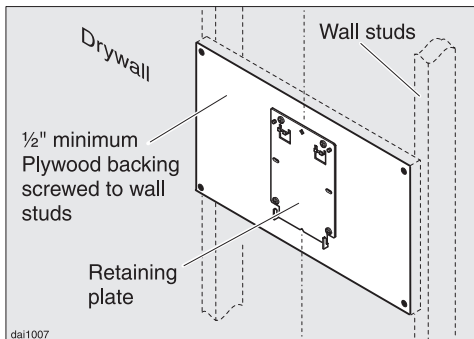

- Determine and mark the location of the retaining plate for the canopy as outlined on the installation sheet.
- Make a cutting line 3" (76 mm) above and 3" (76 mm) below the outline of the retaining plate.

- Find the studs to the left and right of the mounting location by tapping the wall or using a stud finder.
- Mark a vertical cutting line along the center of each stud.

Be careful not to damage any wiring or plumbing that may be located behind the wall. Make sure that the power supply to the area where this installation is being performed has been turned off at the breaker panel before cutting into the wall.

- Remove the drywall between the cutting lines and replace it with plywood of a matching thickness (min. $\frac{1}{2}$ " (13 mm) thick). Tape the joints and refinish the wall.
- Proceed to the included installation sheet to complete the installation.

All electrical work should be performed by a qualified electrician in strict accordance with national and local safety regulations. Installation, repairs and other work by unqualified persons could be dangerous. The manufacturer can not be held responsible for unauthorized work.

Ensure that power to the appliance is OFF while installation or repair work is performed.

Verify that the voltage, load and circuit rating information found on the data plate (located behind the grease filters), match the household electrical supply before installing the hood.

If there is any question concerning the electrical connection of this appliance to your power supply, please consult a licensed electrician or call Miele's Technical Service Department.

USA 1-800-999-1360
CDN 1-800-565-6435

WARNING:
THIS APPLIANCE MUST BE
GROUNDING

Important

The hood comes equipped with a 5 ft (1.5 m) power cord with a NEMA 5-15 molded plug for connection to a 120 VAC, 60 Hz, 15 A power outlet.

Maximum load	420 W
Overhead lighting	3 x 20 W
Indirect lighting	10 W
Voltage	120 V
Frequency	60 Hz
Circuit rating	15 A

Appliance dimensions

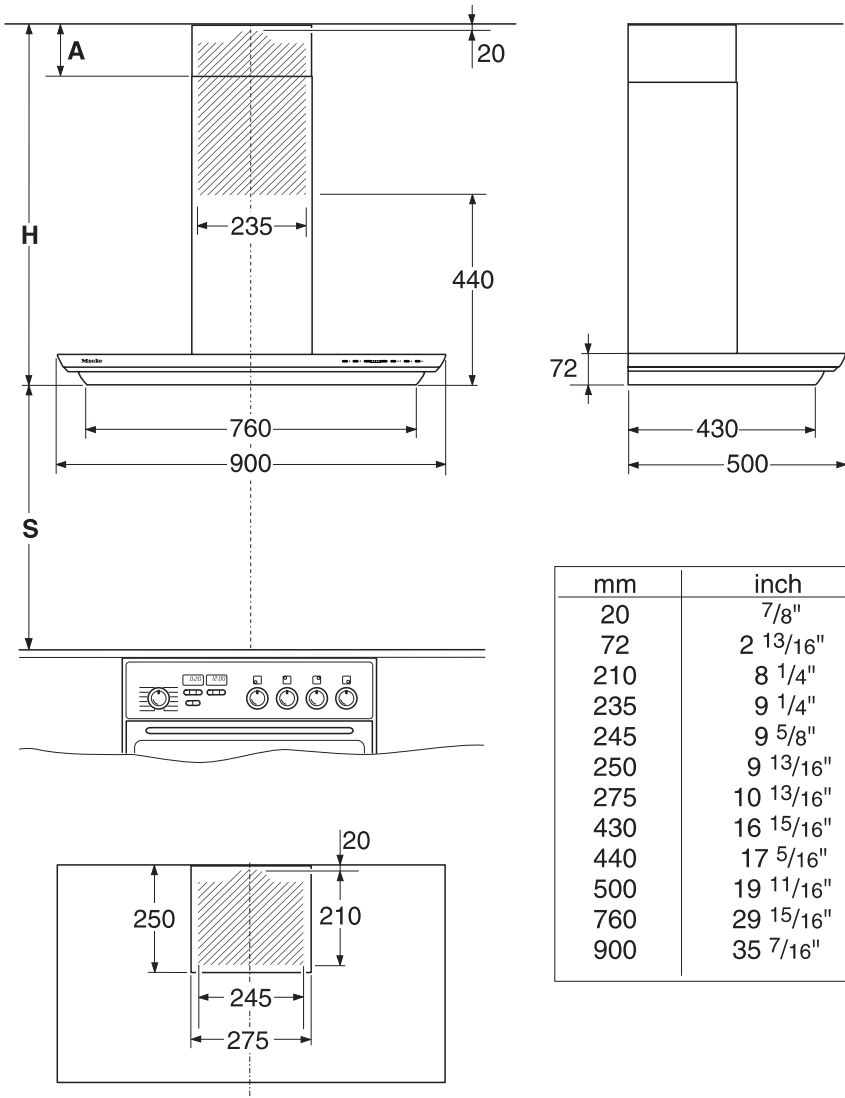

Appliance dimensions

Do not install this exhaust hood over cooktops burning solid fuel.

When installing the hood, make sure that the following **minimum distance (S)** between the top of a Miele cooking surface and the bottom of the hood is:

- 22" (55 cm) above electric cooktops
- 26" (65 cm) above gas cooktops
- 26" (65 cm) above an open grill

For non-Miele cooking appliances maintain the safety distances recommended by the cooktop manufacturer in their installation and operating instructions.

If there is more than one appliance beneath the hood and they have different minimum safety distances always select the greater distance.

See "Important Safety Instructions" for further information.

Standard unit height **H**:

DA 279

Air Extraction. 28 ³/₄ - 39 ¹⁵/₁₆"
. (730 - 1015 mm)

Recirculation. 32 ⁵/₁₆ - 43 ⁵/₁₆"
. (820 - 1100 mm)

To fit the chimney, distance **A** between the top of the chimney and the ceiling must be at least ⁷/₈" (20 mm).

 Cut out area in wall or ceiling for entrance of 6" (150 mm) ductwork or 5" (125 mm) ductwork with a reducing collar.

26" (65 cm) is recommended for all installations to allow for optimum work space under the hood.

Read the entire installation procedure and determine height (**S**) before beginning the installation. Installations differ depending on the model and venting method. If the hood is fitted flush to the ceiling make sure that the remaining distance to the ceiling is not greater or less than appliance height **H**.

Installation

Installation instruction

See the enclosed installation instruction sheet.

Please read the "Important Safety Instructions" and Installation instructions before installing this hood.

Protective film

The casing is covered by a protective film to prevent scratches during transport.

Peel off the film before installing the casing parts.

Dismantling

If the hood needs to be disassembled, follow the instructions on the installation sheet in reverse order.

A lever is enclosed for easier removal of the chimney extension.

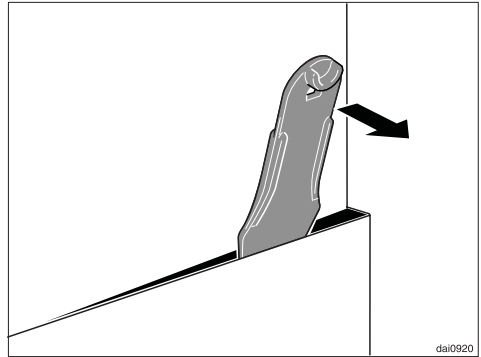

- After removing the screws from the chimney, slide the lever between chimney and chimney extension and gently apply pressure to ease the chimney from its hooks.

 **WARNING**

Danger of toxic fumes.

Gas cooking appliances release carbon monoxide that can be harmful or fatal if inhaled.

The exhaust gases extracted by the hood should be vented outside of the building only.

Do not terminate the exhaust ducts in attics, garages, crawlspaces, etc.

To reduce the risk of fire, only use metal ductwork.

Please read and follow the **"IMPORTANT SAFETY INSTRUCTIONS"** to reduce the risk of personal injury. Follow all local building codes when installing the hood.

Exhaust ducting and connections

- The ducting should be as short and straight as possible, and the number of sharp bends should be minimized.
- For most efficient air extraction, the diameter of the ductwork should not be less than 6" (150 mm). Use of flat ducts also reduces the air extraction efficiency.
- Noise levels of the hood will increase if flat ducts or round ducts of less than 6" (150 mm) in diameter are used.
- Use smooth or flexible pipes made from approved non-flammable materials for exhaust ducting.
- Where the ductwork is horizontal, it must slope away from the hood at least $\frac{1}{8}$ " per foot (1cm per meter) to prevent condensation dripping into the appliance.
- If the exhaust is ducted through an outside wall, a Miele Telescopic Wall Vent can be used.

Air extraction

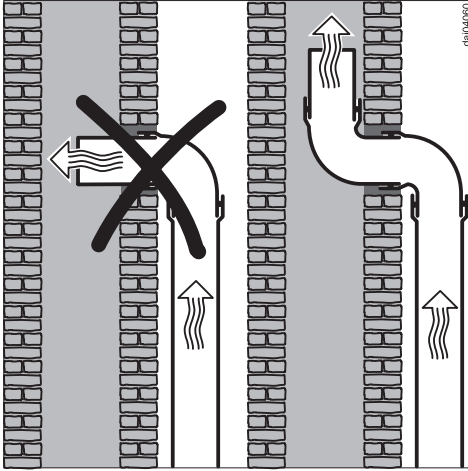

Condensate trap

Important:

If the ductwork runs through rooms, ceilings, garages, etc. where temperature variations exist, it may need to be insulated to reduce condensation. In some cases, a condensate trap may also be required to collect and evaporate any condensate which may occur.

When installing a condensate trap, ensure that it is positioned vertically and if possible directly above the exhaust outlet.

- If the exhaust is ducted into an inactive flue, the air must be expelled parallel to the flow direction of the flue.

Never connect an exhaust hood to an active chimney, dryer vent, vent flue, or room venting ductwork. Seek professional advice before connecting an exhaust hood vent to an existing, inactive chimney or vent flue.



Miele, Inc. (USA)

National Headquarters

9 Independence Way
Princeton, NJ 08540
Phone: 800-843-7231
609-419-9898
Fax: 609-419-4298
www.mieleusa.com

Technical Service & Support

Nationwide

Phone: 800-999-1360
Fax: 888-586-8056

Mid-West Region

Phone: 800-666-6740
Fax: 847-714-9434

South-East Region

Phone: 561-995-8030
Fax: 561-995-8083

West-Coast Region

Phone: 800-245-8215
Fax: 415-241-6822

Miele Limited (CDN)

National Headquarters

55G East Beaver Creek Road
Richmond Hill, ON L4B 1E5
Phone: 800-565-6435
905-707-1171
Fax: 905-707-0177
www.miele.ca
info@miele.ca (general enquiries)
service@miele.ca (tech. service)

Technical Service & Support

Ontario Region

Phone: 905-707-1171
Fax: 905-707-0177

Quebec Region

Phone: 877-636-4353
Fax: 514-277-1838

British Columbia Region

Phone: 604-434-1300
Fax: 604-434-1309